

P19344-B JDP7154-1/Assy-K

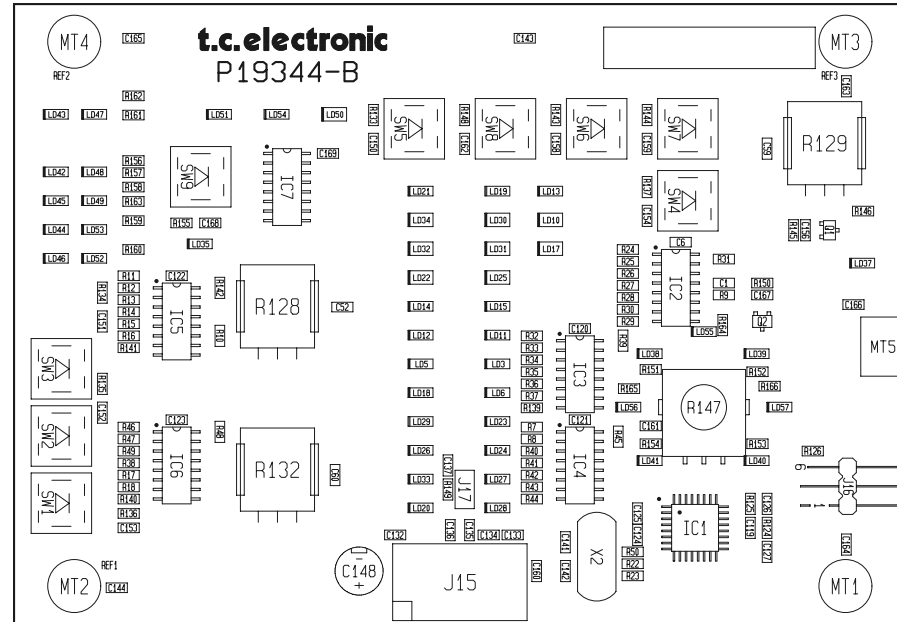

ORIGO

P19344-B 7097124-1\Testpoint\Bottom

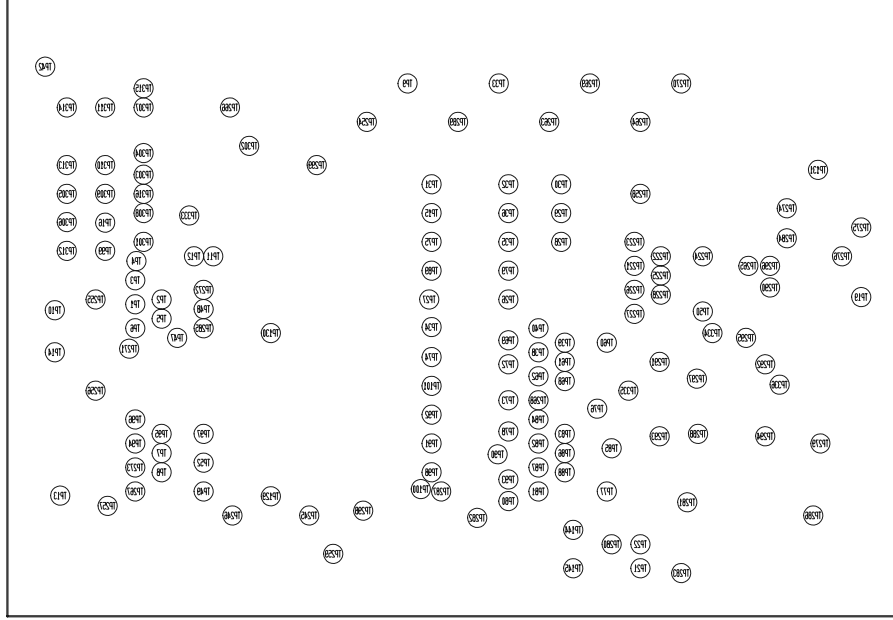

P19344-B JDP7154-1/K

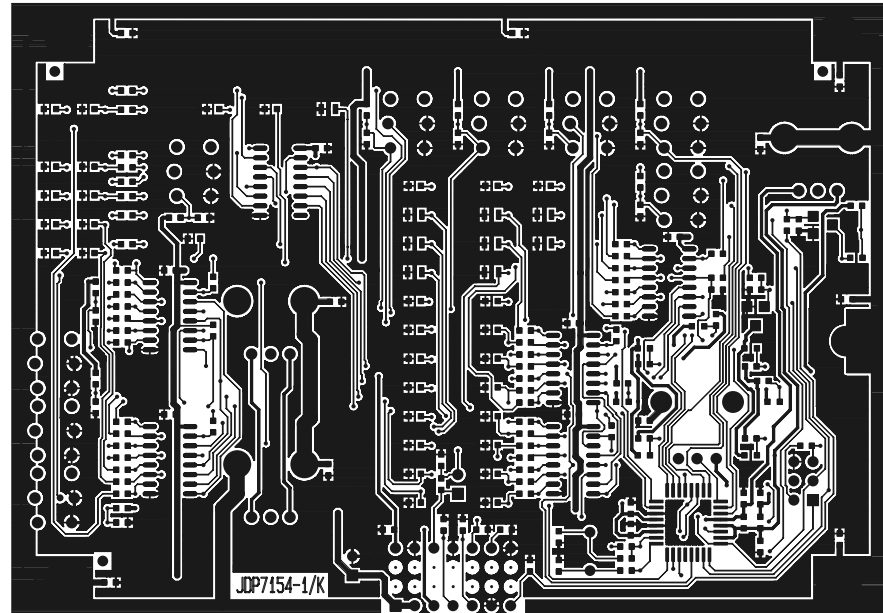

P19344-B JDP7154-1/L

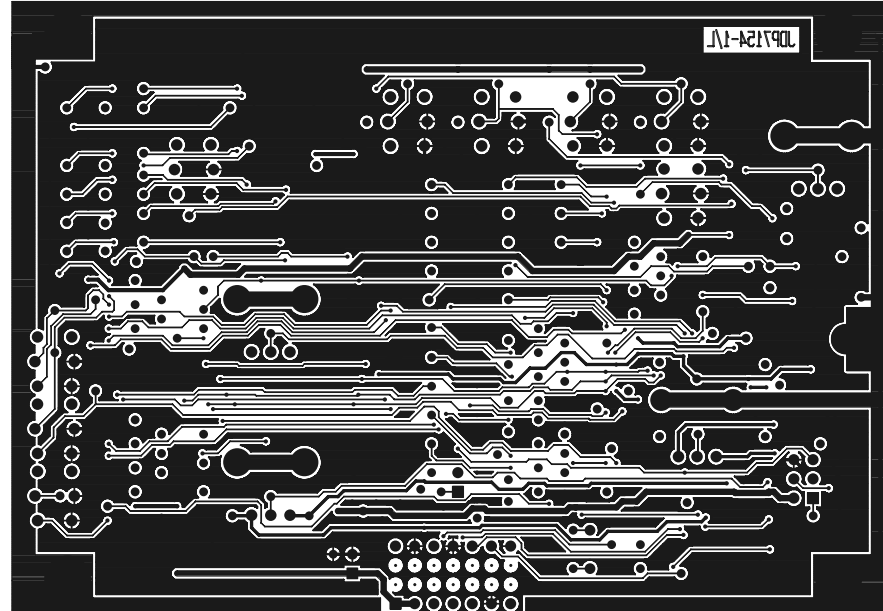

P19344-B JDP7154-1/Mask-K

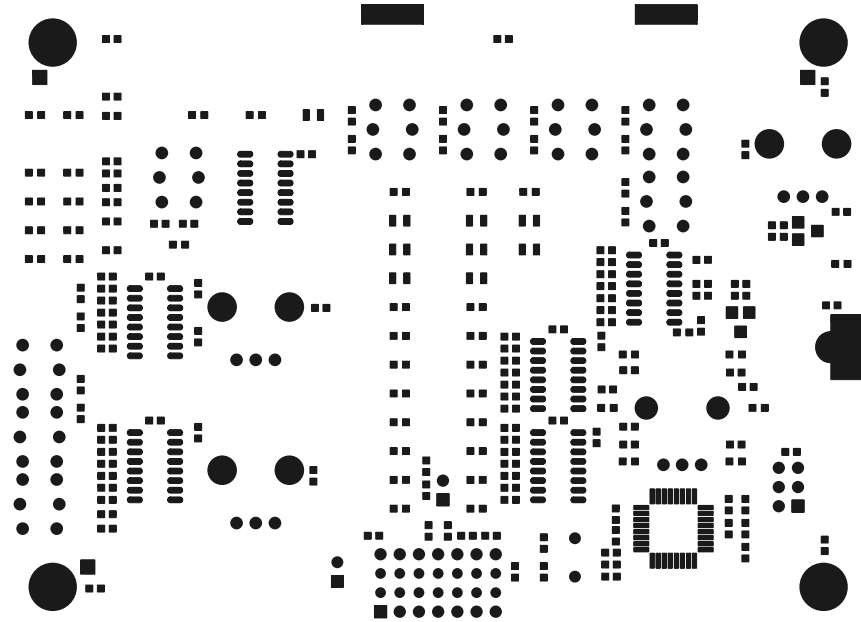

P19344-B JDP7154-1/Mask-L

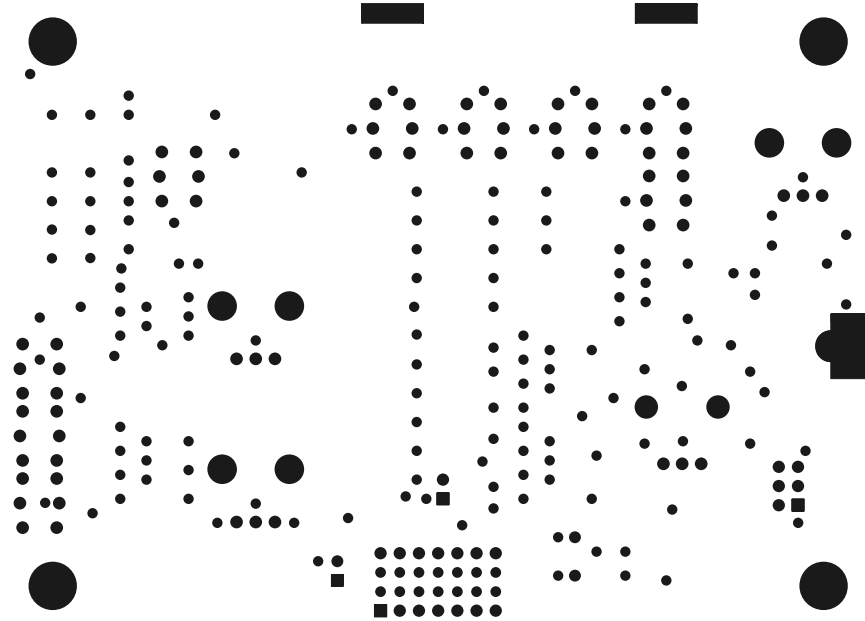

P19344-B JDP7154-1/Silk-K

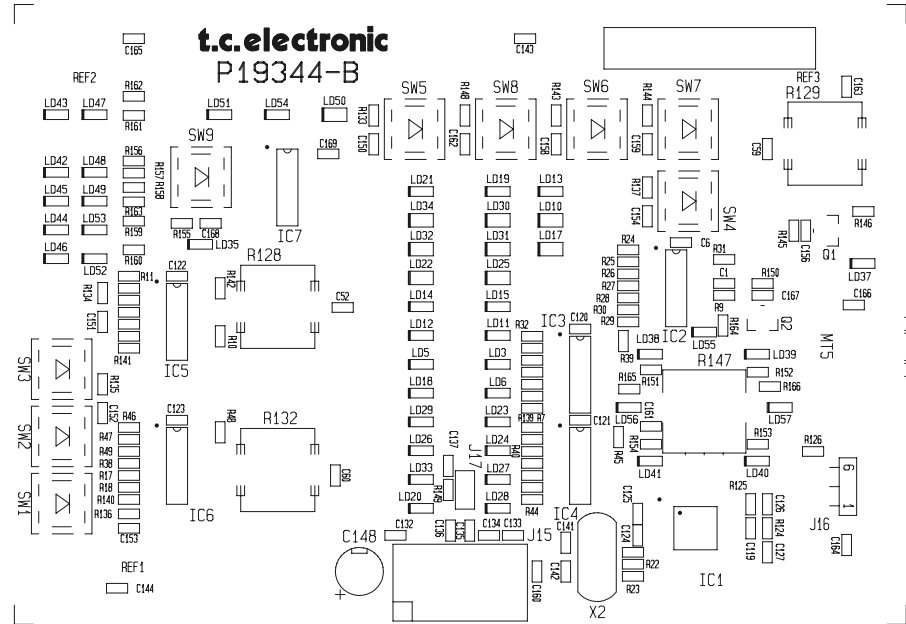

P19344-B JDP7154-1/Pasta-K

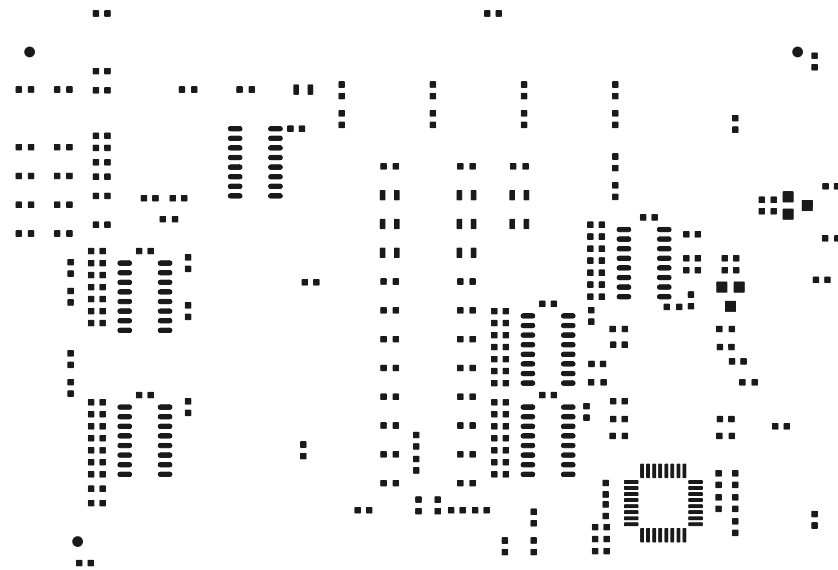

P19344-B JDP7154-1-Milling



P19344-B JDP7154-1/Drill

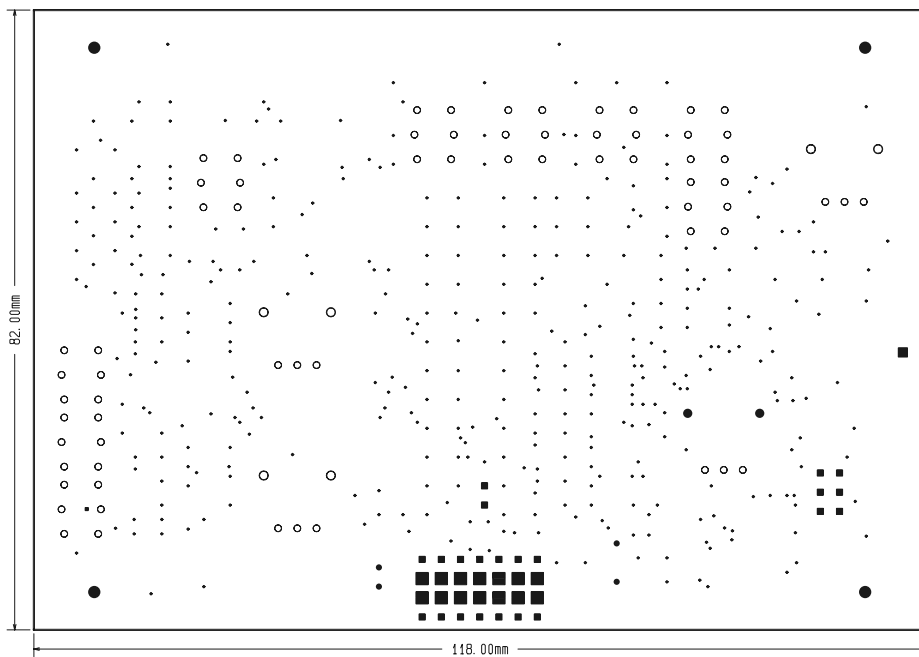

symbol	tool	plated	num	size mm
.	1	y	386	0.3
.	2	y	1	0.6
.	3	y	4	0.8
■	4	y	22	0.9
○	5	y	66	1
●	6	y	2	1.8
■	7	y	1	1.9
○	8	y	6	2.6
●	9	y	4	3.2
■	1	n	14	1.2