

revolution

TANNOY[®]

OWNER'S MANUAL

revolution

CONTENTS

INTRODUCTION	03	BI-AMPING	07
DRIVER TECHNOLOGY	03	GRILLES	08
CABLE CHOICE	04	CENTRE CHANNEL SPEAKER	09
STAND MOUNTING MODELS	05	TECHNICAL SPECIFICATIONS	010
CONNECTION IN SINGLE WIRE MODE	06	SET-UP DIAGRAMS	011-014

WARRANTY

No maintenance of the Revolution loudspeaker is necessary.

Please register your Tannoy product online at www.tannoy.com.

All of our products have been produced and tested with care and precision to give first-class service.

All passive components are guaranteed for a period of five years from the date of purchase from an authorised Tannoy dealer subject to the absence or evidence of misuse, overload, or accidental damage.

All active and electronic components are guaranteed for a period of one year from the date of purchase from an authorised Tannoy dealer subject to the absence of, or evidence of, misuse, overload or accidental damage.

If at any time during this warranty period the equipment proves to be defective for any reason other than accident, misuse, neglect, unauthorised modification or fair wear and tear, we will repair any such manufacturing defect or, at our option, replace it without charge for labour, parts or return carriage.

If you suspect a problem with a Tannoy product then, in the first instance, discuss it with your Tannoy dealer. If you require further assistance then we ask that you deal directly with your local Tannoy distributor. If you cannot locate your distributor please contact Customer Services, Tannoy Ltd at the address given below.

Customer Services, Tannoy Ltd., Rosehall Industrial Estate, Coatbridge, Strathclyde ML5 4TF, Scotland

Telephone: 01236 420199 (National)
+44 1236 420199 (International)
Fax: 01236 428230 (National)
+44 1236 428230 (International)
E-mail: enquiries@tannoy.com

Do not ship any product to Tannoy without previous authorisation.

Our policy commits us to incorporating improvements to our products through continuous research and development. Please confirm current specifications for critical applications with your supplier.

INTRODUCTION

Thank you for selecting Tannoy loudspeakers developed in the UK by our dedicated team of design engineers. They are the choice of discriminating music lovers the world over. Musical excellence is designed into our loudspeakers from the start. Careful selection of the very best components combined with strict quality control procedures in the production process ensures this level of excellence is maintained.

To gain maximum performance from your loudspeakers, please take time to read this owner's manual in full before installation. Once you have set up your new loudspeakers please register them on our website - this does not limit your legal rights.

Loudspeakers are electromechanical devices that 'run-in' through use; performance will therefore improve after an initial period of 24hrs use. Once they have been further run-in over a longer period, there will be clear enhancement of the stereo imaging, mid-band quality and bass performance characteristics.

We are confident that you will continue to enjoy your new Tannoy Revolution loudspeakers for many years to come.

DRIVER TECHNOLOGY

Dual Concentric™

Tannoy Dual Concentric™ drivers have been incorporated into the Revolution loudspeakers. Intensive research and development has produced an all-new version of this proven technology that builds upon the legendary performance of this exclusive Tannoy driver design.

The time coherent, point source and constant directivity nature of the dispersion characteristics inherent in the Dual makes it an accepted industry standard in studio monitoring. By exceeding the rigorous demands of the recording and mastering environment Tannoy can ensure that playback performance in the home for multi channel home cinema, is strictly controlled to accurately reflect the sound engineers artistry. In nature all sounds emanate from a single point in space. The high frequency unit of the Dual, centrally mounted in the throat of the main mid/bass driver, is so positioned as to acoustically replicate this single point source; delivering an incredibly natural sound with an incredibly wide imaging 'sweet spot' that creates an expansive soundstage with remarkably focused placement of images.

WIDEBAND™ TECHNOLOGY

Tannoy has incorporated its own WideBand™ technology into the design of these drivers. Not only does this exceptional in-house technology resolve fine detail of high frequency information but it also effectively enhances the listening experience throughout the whole frequency range. The WideBand™ high frequency system creates an increased immediacy, airiness and impact, making music and movie sound more natural and true to life.

Sounds contain transient information and rich harmonics beyond the range of human hearing for pure tones. Even low frequencies have leading edge transients reaching 30kHz. Tannoy WideBand™ high frequency units will accurately reproduce the leading edge of individual sounds allowing the listener to experience the entire bandwidth, by extending the frequency response to 54kHz.

In addition, the extension of the frequency response, by fully two octaves, corrects time and phase response within the bandwidth of normal human hearing. Taking these acoustical phase anomalies beyond the audible range adds realism to the soundstage through improvements in imaging and the placement of sounds.

AMPLIFIER CHOICE

Consult the enclosed product specification sheet as this clearly shows the acceptable power range for amplifier matching to your speakers. The high peak power handling of Tannoy loudspeakers permits responsible use with more powerful amplifiers - please read the Warranty.

As with all loudspeaker systems, the power handling is a function of voice coil thermal capacity. Care should be taken to avoid overdriving any amplifier, as this will cause output overload resulting in 'clipping' or distortion within the output signal. This, if done for any extended period, will cause damage to the speakers.

Generally an amplifier of higher power that is running hard, but free of distortion, will do less damage to the loudspeaker than a lower power amplifier continually clipping. Remember also that a high powered amplifier running at less than 90% of output power generally sounds a great deal better than a lower powered example struggling to achieve 100%. An amplifier with insufficient drive capability will not allow the full performance of the loudspeakers to be realised.

CABLE CHOICE

Always use the best quality of cable available within your budget. High quality audio signals passing from the amplifier to the loudspeaker are unusual in their demands on the cable. Wide dynamic range and frequency bandwidth information has to coexist with the ability to transmit peak currents of at least 10amps, without incurring any loss or signal impairment. This explains why the sound quality of the information reproduced by the loudspeakers is so dependant on the physical properties of the cables connecting them to the amplifier.

We would recommend that you always keep the cable runs the same length for each speaker. Remember, cable construction can affect the sound quality so be prepared to experiment to find a cable that suits your ear and audio system.

UNPACKING

To unpack the loudspeakers from their boxes remove tape from the top then fold the flaps right back before inverting the carton and contents. Lift the carton clear of the contents then remove all inner packaging.

It is strongly recommended that you store all the packaging to allow protected transportation in future. **(See fig.1)**

FLOOR STANDING MODELS

Revolution floor-standing models perform best with carpet piercing spikes fitted. These are supplied, along with lock nuts, and should be inserted into the threaded holes in the base of the cabinet. Level the speaker and then tighten the lock nuts firmly but without using undue force. Spike locating cups are provided in the accessory pack and these may be used to protect sensitive floor surfaces.

WARNING:

Ensure that the spikes are levelled and that the lock nuts are tightened firmly. The spikes should be pushed through the carpet to locate into the flooring surface by applying pressure to the top of the cabinet.

If using on a sensitive floor surface place the protective cups under the levelled spikes.

Failure to do so could render the speaker unsteady and result in damage or injury should it be knocked over.

STAND MOUNTING MODELS

Stand mounting or bookshelf speakers should be located securely on stands or a shelf in an appropriate position to place the Dual Concentric™ driver high frequency unit roughly at ear height when seated in the chosen listening position. Positioning recommendations for stand-mounted speakers can be found under the section entitled Positioning and fine-tuning.

INSTALLATION

To avoid potential damage to your loudspeaker, ensure that the amplifier is switched OFF prior to connecting or disconnecting any cables. Before switching on double check that all connections are secure and that polarity is correct.

CONNECTION IN SINGLE WIRE MODE

The terminal panels have captive link bars fitted as standard to link the positive and negative HF and LF terminals respectively. These must be removed to bi-wire the speakers - see section entitled Connection in Bi-wire mode.

(See fig. 2)

For optimum performance in single wire mode, loudspeaker cable connections from the amplifier should be made to the high frequency (HF) terminals of the loudspeaker:

- The positive (plus) terminal on the amplifier left channel (marked + or coloured red) must be connected to the positive HF terminal on the left speaker. The left speaker is the one on the left as you look at the stereo pair from your listening position.
- The negative (minus) terminal on the amplifier left channel (marked - or coloured black) must be connected to the negative HF terminal on the left speaker.
- Repeat this connection process for the right speaker. Remember that the positive (+ or red) on the amplifier must be connected to the positive (+ or red) on the speaker and the negative (- or black) to negative.
- Select a signal source, such as a CD player; switch on the amplifier and slowly turn up the volume control to check that both loudspeakers are reproducing bass and treble information. (See fig. 3)

CONNECTION IN BI-WIRE MODE

Please note in bi-wire mode that the link bars must be removed. Unscrew the knurled nuts on both the positive and negative HF and LF terminals and remove the link bar and then replace the colour coded nuts, as they will be required to clamp the bi-wire cables in place. Retain the link bars in a safe place for possible future use.

- Be sure that the amplifier is switched **off** and then prepare the two sets of cabling for each 'side' of the system separately. Measure and cut four lengths of cable, two per speaker.

Label two of the cable lengths Left LF and Left HF (low frequency and high frequency) then repeat this process for the right pair.

- If your amplifier is not equipped with separate output terminals for bass and treble information then, at the amplifier end of the cables, twist the Left LF+ (positive) and the Left HF+ (positive) together. Connect these to the amplifier Left channel positive terminal marked + (plus) or coloured red.

Twist the Left LF- (negative) and the HF- (negative) cables together and connect them to the amplifier Left channel negative terminal marked - (minus) or coloured black.

At the loudspeaker end connect the cables labelled Left LF+ and Left LF- to the left hand loudspeaker LF terminals, ensuring that you note the polarity markings on the cable sheathing.

Then proceed to connect the Left HF+ and Left HF- to the HF terminals on the same loudspeaker.

- Repeat this process to connect the right hand loudspeaker to the amplifier right channel output, once again ensuring that polarity is correct throughout.
- Switch the amplifier on with the volume control set at its lowest setting. Select a favourite source and slowly turn up the volume to a low level. Check that bass and treble information is being reproduced from both speakers - if not, switch off the amplifier and recheck the connections. (See fig. 4)

BI-AMPING

Bi-Amping extends the principle of bi-wiring one stage further. In this connection option separate power amplifiers are used for bass and treble signals in each loudspeaker. Four mono (or two stereo) amplifiers of the same type are required for a stereo pair of loudspeakers. Ensure that the cable links between the loudspeaker terminals are removed and that correct polarity is maintained throughout.

If two stereo amplifiers are used, it is recommended that one amplifier supply bass information to left and right loudspeakers and the other, the treble information. **(See fig. 5)**

POSITIONING AND FINE-TUNING

To get best results from your new Tannoy Revolution loudspeakers it is worthwhile spending a little time finding the optimum set-up configuration.

Begin by angling the speakers towards your chosen listening position, usually this is on the centre line of the room, so that when seated you can just see the inner side panel of each speaker. The front of the loudspeaker should not be obstructed in any way. The loudspeakers should be located between 1.5 to 4.5 metres (5ft to 15ft) apart - with the listening position set slightly further away than the speakers are apart. Avoid positioning the loudspeakers in corners of the room, as this will have a negative effect on performance. Ideally, maintain a distance of at least 0.5 metres (20 inches) from the rear wall, and 1 metre (39 inches) from the side.

With the speaker in its listening position, rock the loudspeaker gently from side to side so that the spikes find their way through the weave of the carpet and on to the solid surface below. Once fine adjustments have been made to the spikes, to level the loudspeaker and ensure stability, tighten the lock nuts firmly but without using undue force.

GRILLES

The main Revolution grille has been designed to provide acoustic transparency. However, for ultimate fidelity the enthusiast will appreciate the slight improvement in clarity and detail that is achieved by removing the grilles during listening.

CARE OF CABINET

The cabinets should only be cleaned with a dry cloth or with a light application of quality non-silicone furniture polish.

REVOLUTION DC HOME THEATRE 5.1 - GENERAL INFORMATION

Unlike other forms of encoded surround audio, 5.1 offers full bandwidth capability for the surround and centre channels, with the ability to treat the subwoofer as a single discreet channel for special effects playback or, for music applications, as a dedicated low frequency instrument channel. This places new demands on the surround and centre channel loudspeakers in both the mixing environment and the playback environment.

The 5.1 format allows the mix engineer in the recording studio to assign audio information to one or more discreet channels of playback; providing very vivid and exacting localisation for the apparent sound sources in the listening environment. To reliably recreate that accurate localisation during playback, the selection and location of loudspeakers becomes the single most critical issue next to the talent of the mix engineer in the studio. **(See fig.7)**

THE SYSTEM

A fully operational 5.1 system consists of two main front loudspeakers, two rear effects speakers at the rear (usually wall mounted) and a centre channel. The subwoofer provides the .1 part of the system.

Total design compatibility, ensuring all models share the same acoustical balance and dispersion characteristics, means that it is essential that an Revolution A/V system is built around only Revolution Dual Concentric™ models (it is not possible to mix in products with other driver types) as the acoustic integration of each has been optimised only for use as a complete system.

In Home Theatre applications this acoustic benefit provides a very focussed soundstage retaining natural voicing and ensuring that aural effects and speech localisation 'pan' from left to right and front to rear seamlessly.

SCREENING

The large magnet assemblies on the loudspeaker drive units of all Revolution models are fully screened to eliminate colour-fringing effects when mounted close to television monitors, but very sensitive models may show some fringing. If that occurs, move the speaker further away from the television monitor.

FRONT SPEAKERS

The ultra wide dynamic range and power handling capability of Revolution loudspeakers will provide a stunning home cinema experience. The speakers should be positioned on either side of the TV or projection screen and then placed in line with the screen surface.

CENTRE CHANNEL SPEAKER

In all cases the centre channel speaker should be positioned as near to the TV screen as possible. The viewing position when seated determines the ideal mounting height, but in all cases this should be as close as possible to ear height. As with the main speakers the front baffle panel should be as near as possible in line with the screen surface.

The Revolution DC LCR centre channel can be wired in single wire, bi-wire or bi-amp modes. Please refer to figs. 3, 4 & 5 for connection guidance bearing in mind that connection should be made to the dedicated centre channel output on your A/V processor amplifier/s.

WARNING:

Only use the support platform provided with the Revolution DC4LCR. It is not recommended that speaker be balanced on top of the tv or plasma screen.

REAR EFFECTS SPEAKERS

The integrity of the special effects soundstage created by the source material will be compromised if the speakers are installed on the sidewalls, for that reason they should always be placed behind the main viewing position. The placement of floor standing or stand mounted speakers at the rear should mirror as near as possible the location of the front pair and 0.5 metres (20 inches) from the rear wall.

SUBWOOFER

As the subwoofer only produces low frequency, therefore monaural information, it is difficult to detect its location by ear. It could as a result be situated anywhere in the room, but optimum performance will be gained by locating the subwoofer between the main stereo pair of speakers. Bass output will increase when placed next to a wall or in a corner so use the subwoofer volume control to balance the output with the rest of the system.

Please refer to the manual supplied with the subwoofer for advice on installation and set-up.

TECHNICAL SPECIFICATIONS

	Revolution DC4	Revolution DC4 T	Revolution DC4LCR
PERFORMANCE			
Recommended amplifier power (Watts RMS)	20 – 100	20 – 125	20 – 125
Continuous power handling (Watts Peak RMS)	50	62	62
Peak power handling (Watts)	200	250	250
Sensitivity (2.83 Volts @ 1m)	87dB	87dB	87dB
Nominal Impedance (Ohms)	8	8	8
Frequency response (-6dB)	68Hz – 54kHz	54Hz – 54kHz	72Hz – 54kHz
Dispersion (degrees conical)	90	90	90
DRIVE UNITS			
Dual Concentric™ high frequency	19mm (0.75") Titanium dome With Tulip WaveGuide™	19mm (0.75") Titanium dome With Tulip WaveGuide™	19mm (0.75") Titanium dome With Tulip WaveGuide™
Dual Concentric™ low frequency	100mm (4") treated paper pulp cone with Rubber surround. 33mm (1.33") edge wound voice coil	100mm (4") treated paper pulp cone with Rubber surround. 33mm (1.33") edge wound voice coil	100mm (4") treated paper pulp cone with Rubber surround. 33mm (1.33") edge wound voice coil
Bass Driver	- - - - -	100mm (4") treated paper pulp cone with Rubber surround. 33mm (1.33") edge wound voice coil	100mm (4") treated paper pulp cone with Rubber surround. 33mm (1.33") edge wound voice coil
CROSSOVER			
Crossover frequency	1.5kHz	1.5kHz	1.5kHz
Crossover Type	Passive low loss 2nd order LF, 1st order HF	Passive low loss 2nd order LF, 1st order HF	Passive low loss 2nd order LF, 1st order HF
CONSTRUCTION			
Enclosure type	Rear ported	Rear ported	Rear ported
Volume	3.43L (0.121 cu. ft.)	11.73L (0.414 cu. ft.)	3.95L (0.139 cu. ft.)
Dimensions (H x W x D) excl grille	270 x 152 x 162mm (10.63 x 5.98 x 6.38")	850 x 152 x 162mm (33.46 x 5.98 x 6.38")	152 x 307 x 162mm (5.98 x 12.08 x 6.38")
Weight	3.7kg (8.2lbs)	9.1kg (20.1lbs)	5.2kg (11.4lbs)
Finish	Light oak and Espresso	Light oak and Espresso	Light oak and Espresso

SET-UP DIAGRAMS

Fig.1 Unpacking

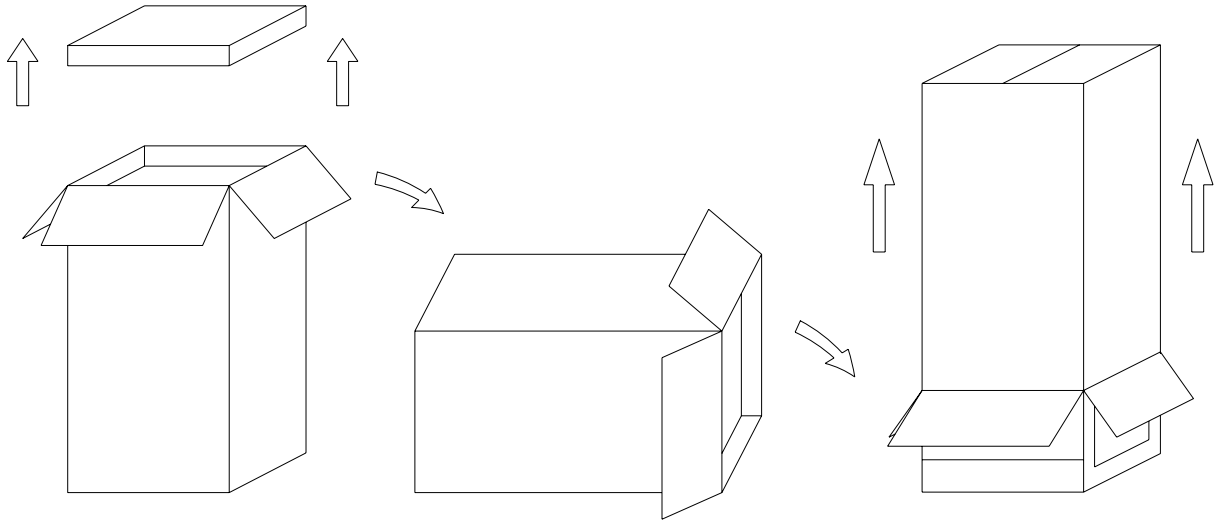

SET-UP DIAGRAMS

Fig.2 DC Terminal Panel

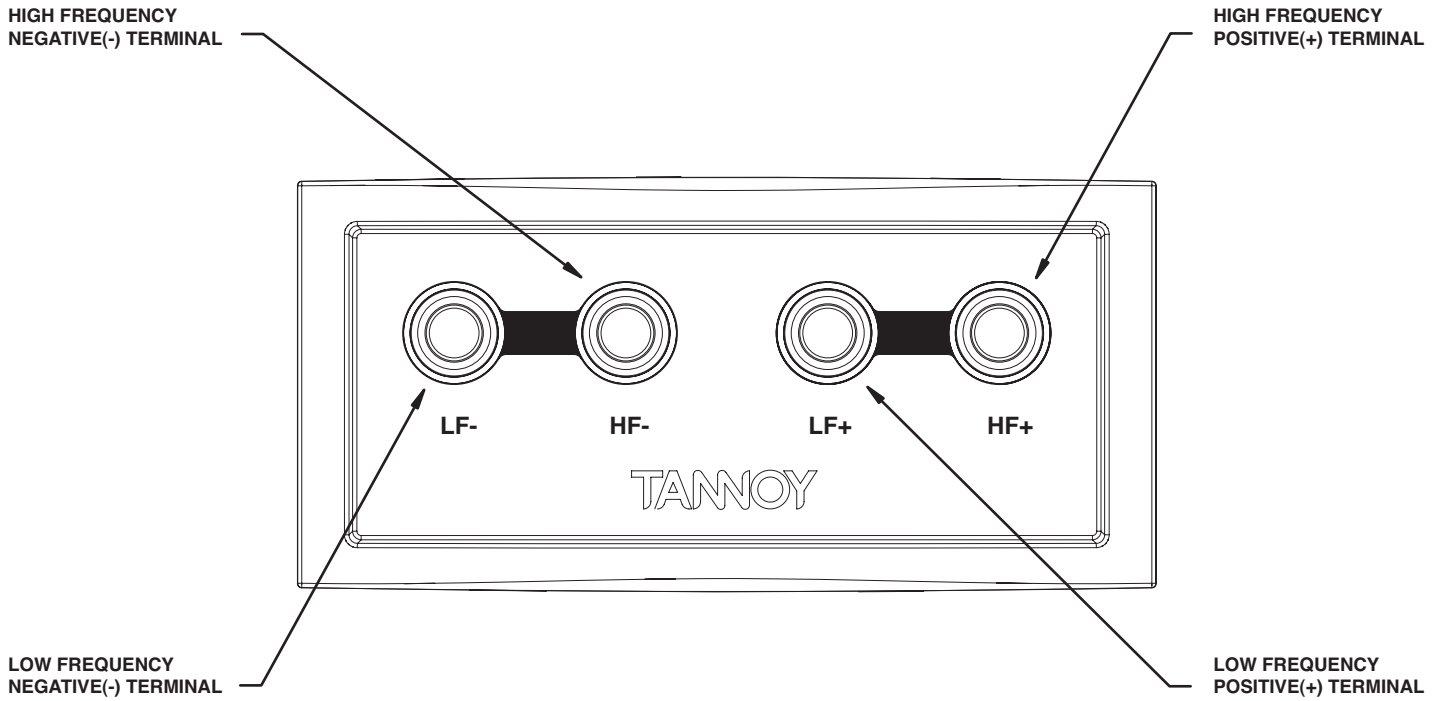
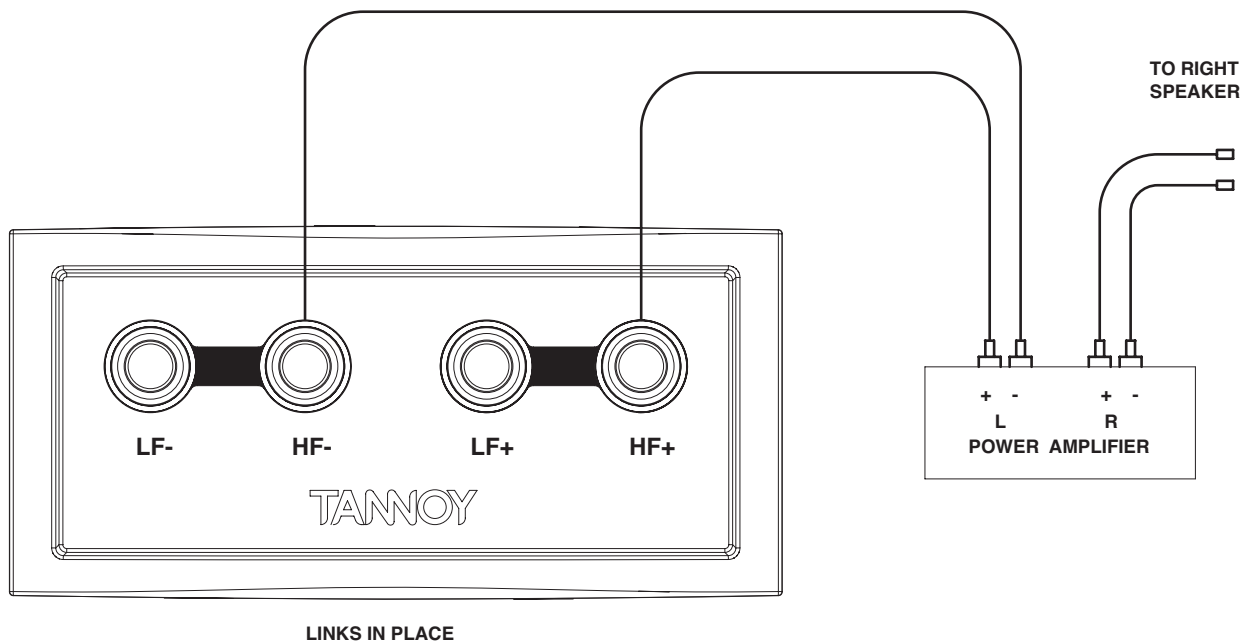

Fig.3 Single Wire Mode



SET-UP DIAGRAMS

Fig.4 Bi-Wire Mode

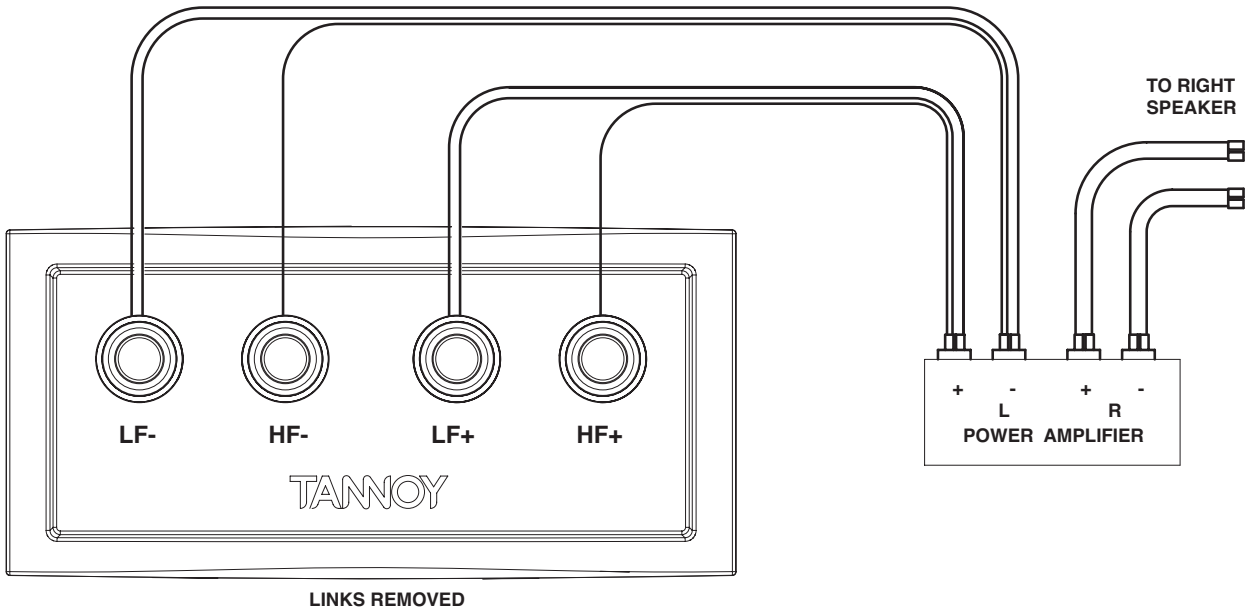
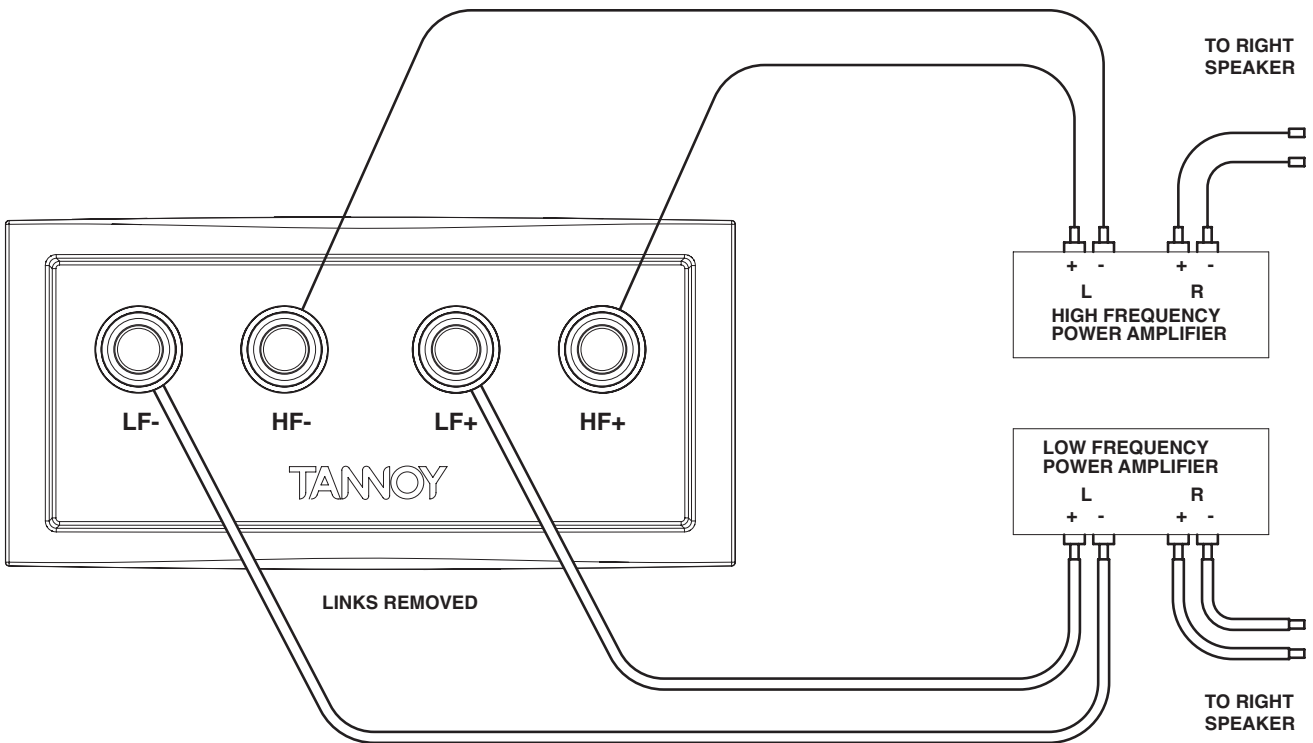

Fig.5 Bi-Amp Mode



SET-UP DIAGRAMS

Fig.6 Recommended Positioning - Stereo Pair

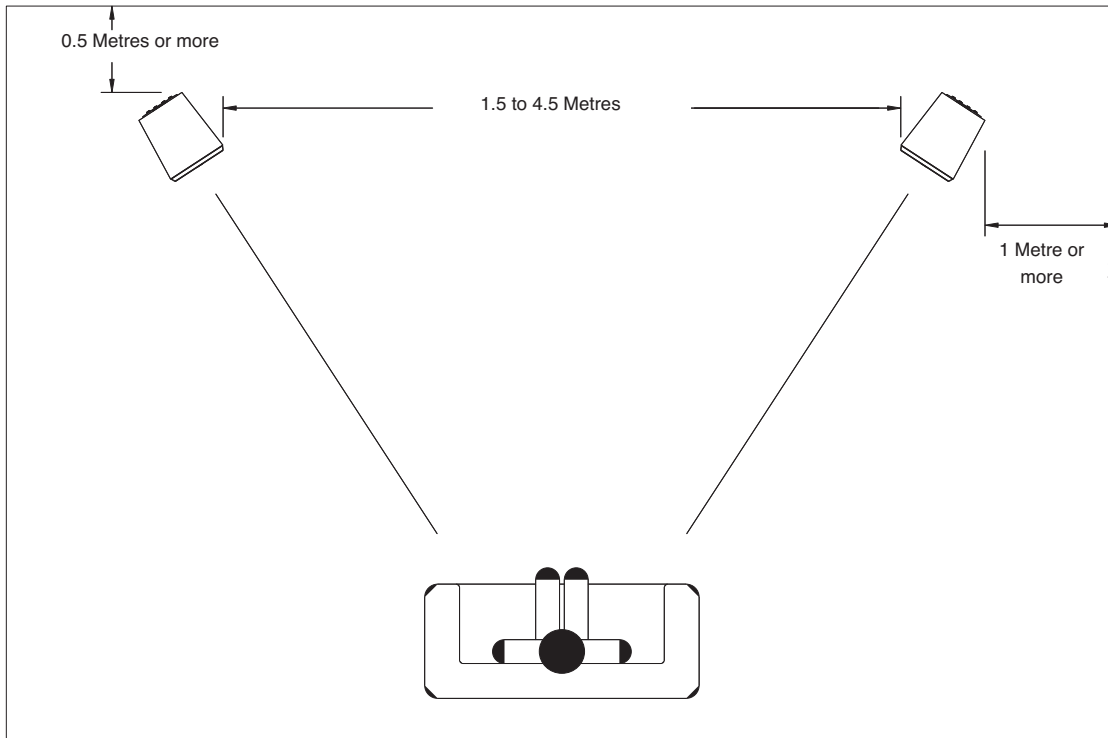
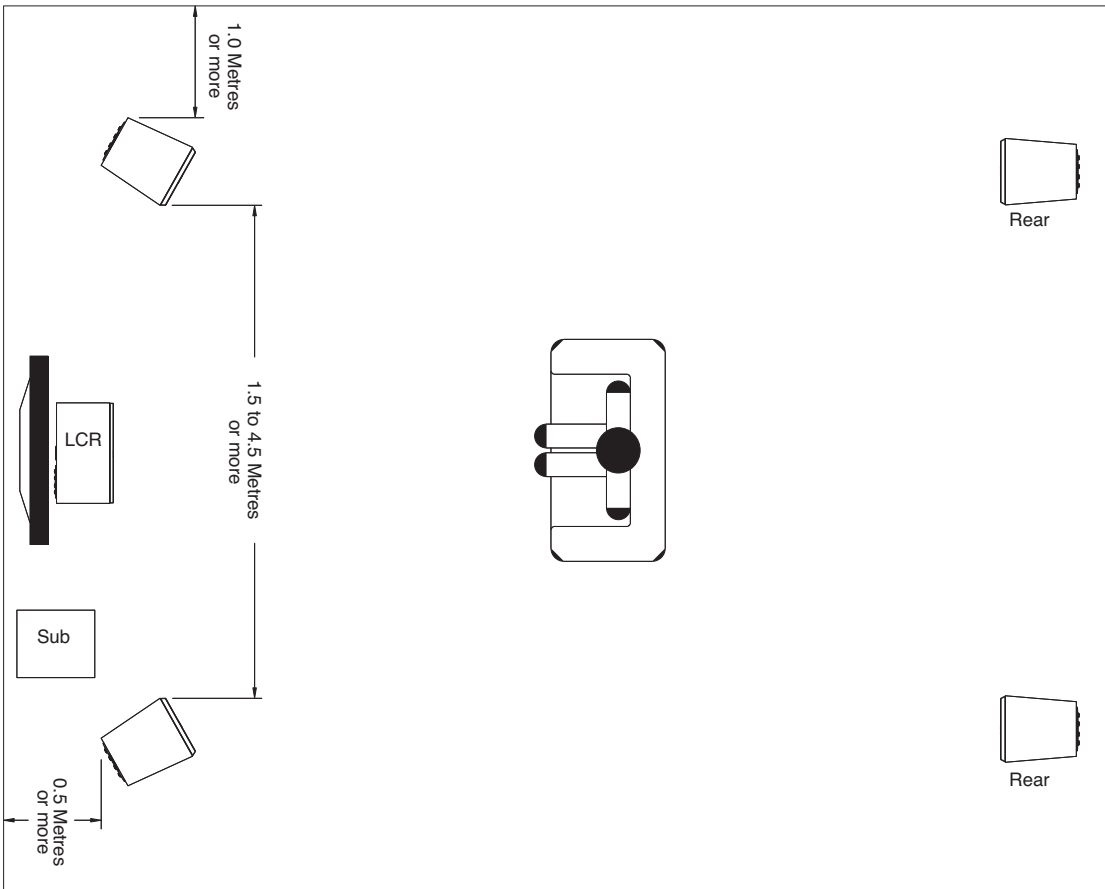

Fig.7 Recommended Positioning - Home Cinema



NOTES

Tannoy United Kingdom	T: 00 44 (0) 1236 420199	E: enquiries@tannoy.com
Tannoy North America	T: 00 1 (519) 745 1158	E: inquiries@tannoyna.com
Tannoy Deutschland	T: 00 49 (180) 1111 881	E: anfragen@tannoy.com
Tannoy France	T: 00 33 (0)1 7036 7473	E: ventes@tannoy.com



Tannoy adopts a policy of continuous improvement and product specification is subject to change.

tannoy®.com